



Archived resources

For further resources and
documentation please visit us:
www.cinos.net

10.1" Modero X[®] Series Wall Mount Touch Panel

MXD-1000-P (FG5968-07) Portrait Wall Mount Touch Panel

MXD-1000-L (FG5968-13) Landscape Wall Mount Touch Panel

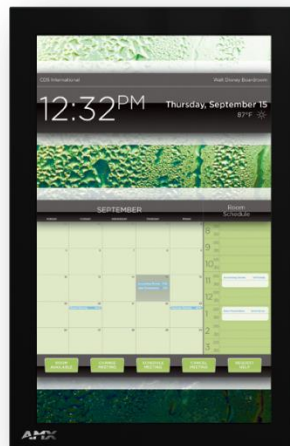

Overview

The Modero X Series is the most elegant family of interfaces designed specifically for dedicated room control. This new generation of touch panels is built for usability offering edge-to-edge capacitive touch glass with multi-touch capabilities. It features advanced technology empowering users to operate AV equipment seamlessly, while providing the ultimate in audio and video quality. The distinctive appearance will complement even the most sophisticated meeting facilities and homes. With a lightning fast processor, brilliant graphics and enhanced capabilities, the Modero X Series is the control surface that simply delivers more.

Common Applications

The MXD-1000 is ideal for boardrooms, conference rooms or auditoriums where a control surface is needed to provide access to key functions. In residences, it is perfect for kitchens, home theaters or home offices where it can be used to manage systems throughout the house.

Features

- **Latest Communication Technologies** – Supports Near Field Communication (NFC) - short-range wireless technologies that deliver peer-to-peer communication by 'sharing, pairing and transaction' between RF devices like exchanging data/identities
- **Enhanced Usability** – External phone connections via Bluetooth or USB and HD video streaming
- **Graphic Leaps & Bounds** – The Modero X Series features intuitive UI functionality including: gesturing, swiping, dynamic reordering and enhanced animation capabilities

- **Perfect From Any Angle** – Includes In-Plane Switching (IPS), the latest technology in popular tablet/mobile devices that delivers the widest viewing angles and the most accurate color reproduction on the market
- **Available Rack Mounting Kit** – As an option, you can mount the 10.1" Modero X Series Landscape Wall/Flush Mount Touch Panel directly to an equipment rack using the MXA-RMK-10 Modero X Series Rack Mount Kit (FG5969-62). The Kit includes a rack mount frame, screws and washers

Dealer Benefits

- **Attract More Corporate Customers** - The elegant design and simple beauty of the Modero X Series will create demand from both new and current customers
- **Address Unique Requirements** – With edge-to-edge glass and capacitive touch, the Modero X Series Touch Panels provide dealers with a control surface that is unobtrusive and simple to use
- **Differentiate Yourself** – The Modero X Series offers design and technology features unmatched in the industry

Customer Benefits

- **Simple to Use Interfaces** – The capacitive multi-touch and gesture-based screen makes it easy for anyone to operate sophisticated meeting room or home theater equipment
- **Range of Sizes** – The contemporary design with edge-to-edge glass is available in 4.3", 7", 10.1" as well as 19.4" and 20.3" panoramic sizes for applications in any room
- **Choose Horizontal or Vertical Orientation** - The 10.1" Modero X Series Wall/Flush Mount Touch Panel has models engineered to mount horizontally or vertically giving design flexibility for specific applications such as room scheduling

Specifications

TOUCH SCREEN DISPLAY	
Display Type	TFT Active Matrix Color LCD with In-plane Switching Technology (IPS)
Display Size (WH)	Landscape: 9.9" x 6.7" (252 mm x 170 mm), Portrait: 6.7" x 9.9" (170 mm x 252 mm), 12.0" (304 mm) diagonal
Viewable Area (WH)	Landscape: 8.5" x 5.3" (217mm x 136mm), Portrait: 5.3" x 8.5" (136 mm x 217 mm), 10.1" (257mm) diagonal
Resolution (WH)	Landscape: 1280x800, Portrait: 800x1280
Aspect Ratio (WH)	Landscape: 16:9, Portrait: 9:16
Brightness	400 cd/m2
Contrast Ratio	700:1
Color Depth	264K colors
Illumination	LED
Touch Overlay	Projected Capacitive, multi-touch support, 3 simultaneous max
Viewing Angle	Vertical ± 89°, Horizontal ± 89°

MEMORY	
SDRAM	512 MB
Flash	4 GB
Maximum Project Size	2.4 GB flash available to user

COMMUNICATIONS	
ETHERNET	10/100 port, RJ-45 connector. Supported IP and IP-Based Protocols: UCP, TCP, ICMP, ICSP, IGMP, DHCP, Telnet, FTP, DNS, RFB (for VNC), HTTP
USB	(2) USB host 2.0, Type A ports (1 with limited physical access requiring right angle connection): Firmware

	<p>upgrade, touch panel file transfer, JPEG image viewer, HID peripherals, USB audio output for headsets</p> <p>(1) Micro-USB device port: video output from on-board camera (landscape touch panel only), USB audio from on-board microphone to host device</p>
Near Field Communication (NFC)	Supports standards ISO/IEC 15693, ISO/IEC 14443A, ISO/IEC 14443B; Unique Identifier (UID), typ range = .25", max = .5"
Bluetooth	<p>Mouse/Keyboard: HID Profile v1.1, requires MXA-BT Bluetooth Adapter (FG5968-19)</p> <p>Handset: Hands Free Profile v1.5, Headset Profile v1.2, requires MXA-BT Bluetooth Adapter (FG5968-19) and MXA-HST Bluetooth Handset (FG5968-17)</p>

VIDEO	
Supported Video Codecs, Landscape Model (FG5968-13)	<p>MPEG-2-TS: MPEG-2 Main Profile@High Level up to 720p at 25 fps (decode only)</p> <p>MPEG-2-TS: H.264 High Profile@Layer 4, AAC-LC up to 720p at 25 fps (encode/decode)</p> <p>MJPEG up to 720p at 25 fps (decode only)</p>
Supported Video Codecs, Portrait Model (FG5968-07)	<p>MPEG-2-TS: MPEG-2 Main Profile@High Level up to 720p at 25 fps (decode only)</p> <p>MPEG-2-TS: H.264 High Profile@Layer 4, AAC-LC up to 720p at 25 fps (decode)</p> <p>MJPEG up to 720p at 25 fps (decode only)</p>
Supported Video Transport Streams	MPEG-TS for MPEG2 and H.264; HTTP for MJPEG
Max Number of Active Video Streams	Portrait: One decode Landscape: One decode plus one encode
Video Conferencing, Landscape Model (FG5968-13)	Panel-to-panel and video chat
Video Conferencing, Portrait Model (FG5968-07)	Panel-to-panel and video chat (the portrait wall mount receives video and returns audio)
Video Output, Landscape Model Only (FG5968-13)	Camera video output: H.264, up to 720p@25 fps via Micro-USB port only (controlled by host device)

AUDIO	
Microphone	-42dB +- 3dB sensitivity FET microphone
Speakers	4 ohm, 2 Watt, 300Hz cutoff frequency
Supported Audio Codecs	<p>MP2 Layer I and II, MP3 (8 kHz, 11.025 kHz, 12 kHz, 16 kHz, 22.05 kHz, 24 kHz, 32 kHz, 44.1 kHz, 48 kHz)</p> <p>AAC-LC (8 kHz, 96 kHz)</p> <p>G.711 with μLaw (VoIP encode/decode at 8kHz)</p>
Audio Output	USB Audio out Micro-USB port (head/hand set support)
File Formats	WAV, MP3 (as part of touch panel file only - no USB storage)
Intercom	Full Duplex VoIP, SIP v2.0 (supported with AMX-CSG)

GRAPHICS ENGINE	
AMX G4	G4 enhanced feature set supporting multi-touch and

	gestures, scrolling, transitions - See TPD4 Operations Guide for more information
--	---

EMBEDDED APPLICATIONS	
Remote Management	VNC Server, G4 Web Control, AMX Resource Management Suite
Video Conferencing	Panel-to-panel and video chat
Audio Conferencing	Audio (full duplex intercom)

FRONT PANEL COMPONENTS	
Light Sensor	Photosensitive light detector for automatic adjustment of the panel brightness
Proximity Detector	Max range = ~3', typ range = ~1', FOV = ~10 degrees
Camera, Landscape Model Only (FG5968-13)	HD 720p camera for video conferencing/video chat support
LED indicators, Landscape Model Only (FG5968-13)	Camera active indicator (models with camera only)
Sleep Button	Sleep button to activate sleep mode and powering off. Also provides access to setup pages (can be disabled)

CONNECTIONS	
Ethernet	10/100 port, RJ-45 connector
USB	(2) USB host 2.0, Type A ports (1) Micro-USB device port
Power	PoE (Power over Ethernet), 802.3af, class 3

ENVIRONMENTAL	
Temperature (Operating)	32° F to 104° F (0° C to 40° C)
Temperature (Storage)	4° F to 140° F (-20° C to 60° C)
Humidity (Operating)	20% to 85% RH
Humidity (Storage)	5% to 85% RH
Power ("Heat") Dissipation	On: 21.3 BTU/hr Standby: 10.6 BTU/hr

GENERAL	
Dimensions (HWD)	Landscape: 6 11/16" x 9 7/8" x 2 5/8" (171 mm x 252 mm x 67 mm), Portrait: 9 7/8" x 6 11/16" x 2 5/8" (252 mm x 171 mm x 67 mm)
Weight	2.0 lbs (0.91 Kg)
Power Consumption	Full-On: 8 W (max.) Standby: 3.2 W Shutdown: 1 W
Start-Up Inrush Current	Not applicable due to PoE standard
External Power Supply Required	AMX recommends using one of these AMX approved PoE power supplies (not included): PS-POE-AF-TC, PoE Injector, 802.3AF Compliant (FG423-83) NXA-ENET8-2POE, Gigabit PoE Ethernet Switch (FG2178-63)
Certifications	UL 60950-1 FCC Part 15 Class B C-Tick CISPR 22 Class B CE EN 55022 Class B and EN 55024 CB Scheme IEC 60950-1

	<p>IC IEC/EN-60950 RoHS/WEEE compliant</p>
Included Accessories	<p>MXA-USB-C, USB Port Cover Kit, Modero X Series Touch Panel (FG5968-18) 3/4" Mini-Grommet (FG570-01) MXA-CLK, Modero X Series Cleaning Kit (FG5968-16)</p>
Optional Accessories	<p>MXA-MP, Modero X Series Multi Preview (FG5968-20) MXA-MPL, Modero X Series Multi Preview Live (FG5968-10) PS-POE-AF-TC, PoE Injector, 802.3AF Compliant (FG423-83) CB-MXP10, Rough-In Box and Cover Plate for Modero X Series Touch Panel, 10" (FG039-17) MXA-BT Bluetooth USB Adapter for Modero X Series (FG5968-19) MXA-CLK, Modero X Series Cleaning Kit (FG5968-16) NXA-ENET8-2POE, Gigabit PoE Ethernet Switch (FG2178-63) MXA-HST, Bluetooth Handset for Modero X Series Touch Panels (FG5968-17) CSG, Communications Gateway (FG2182-01,-02,-03)</p>

For more detailed pictorial drawings please visit: <http://www.amx.com/assets/drawings/95-5968-07.pdf>
<http://www.amx.com/assets/drawings/95-5968-13.pdf>

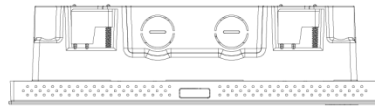
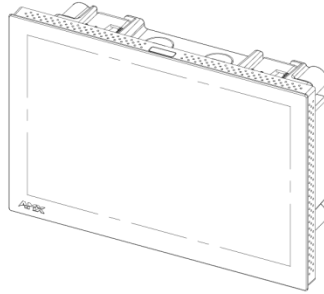
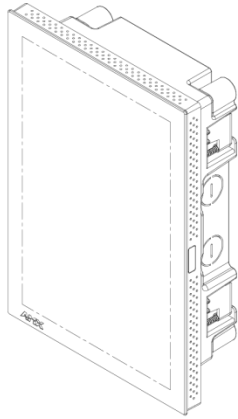

MXD-1000-L
(Landscape - Top View)



MXD-1000-P
(Portrait - Front View)

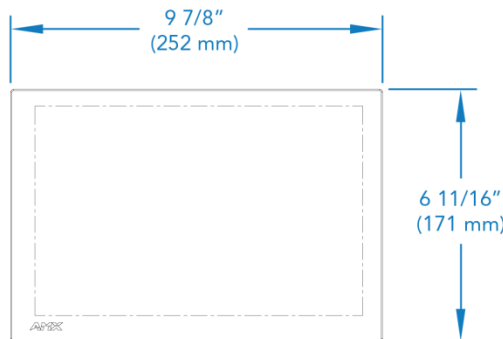

MXD-1000-L
(Landscape - Front View)

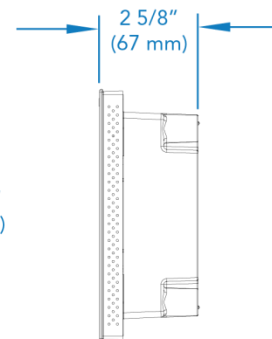

MXD-1000-L
(Landscape - Right View)

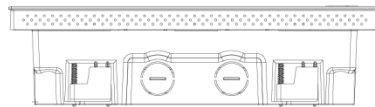

MXD-1000-L
(Landscape - Bottom View)

About AMX

AMX hardware and software solutions simplify the implementation, maintenance, and use of technology to create effective environments. With the increasing number of technologies and operating platforms at work and home, AMX solves the complexity of managing this technology with reliable, consistent and scalable systems. Our award-winning products span control and automation, system-wide switching and audio/video signal distribution, digital signage and technology management. They are implemented worldwide in conference rooms, homes, classrooms, network operation / command centers, hotels, entertainment venues, broadcast facilities, and more. ©2012 AMX. All rights reserved.
Specifications subject to change. Revised 19-March-13.

AMX.com | 800.222.0193 | 469.624.8000 | +1.469.624.7400 | fax 469.624.7153

For further resources and
documentation please visit us:
www.cinos.net